

# Multifunctional three-phase monitoring relays CM-MPS CM-MPS.11, CM-MPS.21, CM-MPS.31 and CM-MPS.41

The three-phase monitoring relays CM-MPS.x1 monitor the phase parameters phase sequence, phase failure, over- and undervoltage as well as phase unbalance.

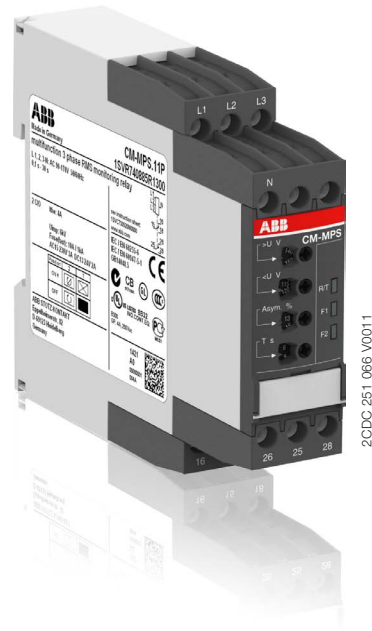





All devices are available with two different terminal versions. You can choose between the proven screw connection technology (double-chamber cage connection terminals) and the completely tool-free Easy Connect Technology (push-in terminals).



## Characteristics

- Monitoring of three-phase mains for phase sequence (can be switched off), phase failure, over- and undervoltage as well as phase unbalance
- TRMS measuring principle
- Interrupted neutral monitoring (CM-MPS.11 and CM-MPS.21)
- CM-MPS.11 and CM-MPS.21 can also be used to monitor single-phase mains
- Threshold values for over- and undervoltage as well as phase unbalance are adjustable as absolute values
- Tripping delay  $T_V$  can be adjusted or switched off by means of a logarithmic scale (0 s; 0.1-30 s)
- ON-delayed or OFF-delayed tripping delay selectable
- Powered by the measuring circuit
- Precise adjustment by front-face operating controls
- Screw connection technology or Easy Connect Technology available
- Housing material for highest fire protection classification UL 94 V-0
- Tool-free mounting on DIN rail as well as demounting
- 2 c/o (SPDT) contacts
- 22.5 mm (0.89 in) width
- 3 LEDs for the indication of operational states

## Approvals

-  UL 508, CAN/CSA C22.2 No. 14
-  GL
-  GOST
-  CB scheme
-  CCC
-  RMRS

## Marks

-  CE
-  C-Tick

## Order data

### Three-phase monitoring relays

Type	Rated control supply voltage = measuring voltage	Interrupted neutral monitoring	Connection technology	Order code
CM-MPS.11P	3 x 90-170 V AC	yes	Push-in terminals	1SVR 740 885 R1300
CM-MPS.11S		yes	Screw terminals	1SVR 730 885 R1300
CM-MPS.21P	3 x 180-280 V AC	yes	Push-in terminals	1SVR 740 885 R3300
CM-MPS.21S		yes	Screw terminals	1SVR 730 885 R3300
CM-MPS.31P	3 x 160-300 V AC	no	Push-in terminals	1SVR 740 884 R1300
CM-MPS.31S		no	Screw terminals	1SVR 730 884 R1300
CM-MPS.41P	3 x 300-500 V AC	no	Push-in terminals	1SVR 740 884 R3300
CM-MPS.41S		no	Screw terminals	1SVR 730 884 R3300

### Accessories

Type	Description	Order code
ADP.01	Adapter for screw mounting	1SVR 430 029 R0100
MAR.12	Marker label for devices with DIP switches	1SVR 730 006 R0000
COV.11	Sealable transparent cover	1SVR 730 005 R0100

## Connection technology

Maintenance free Easy Connect Technology with push-in terminals

Type designation CM-xxS.yyP

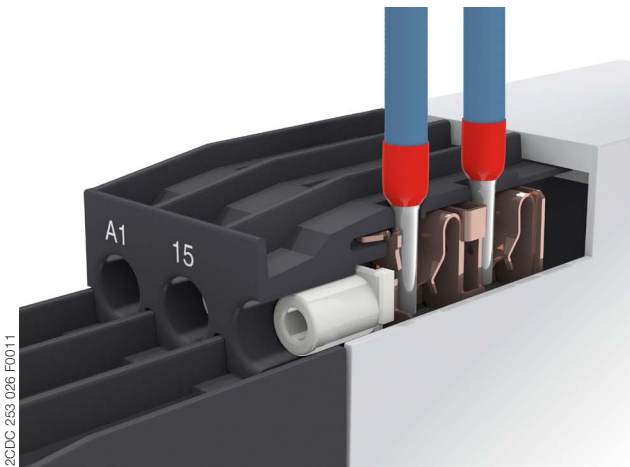

### Push-in terminals

- Tool-free connection of rigid and flexible wires with wire end ferrule according to DIN 46228-1-A, DIN 46228-4-E  
Wire size: 2 x 0.5-1.5 mm<sup>2</sup>, (2 x 20 - 16 AWG)
- Easy connection of flexible wires without wire end ferrule by opening the terminals
- No retightening necessary
- One operation lever for opening both connection terminals
- For triggering the lever and disconnecting of wires you can use the same tool (Screwdriver according to DIN ISO 2380-1 Form A 0.8 x 4 mm (0.0315 x 0.157 in), DIN ISO 8764-1 PZ1 ø 4.5 mm (0.177 in))
- Constant spring force on terminal point independent of the applied wire type, wire size or ambient conditions (e. g. vibrations or temperature changes)
- Opening for testing the electrical contacting
- Gas-tight

Approved screw connection technology with double-chamber cage connection terminals

Type designation CM-xxS.yyS

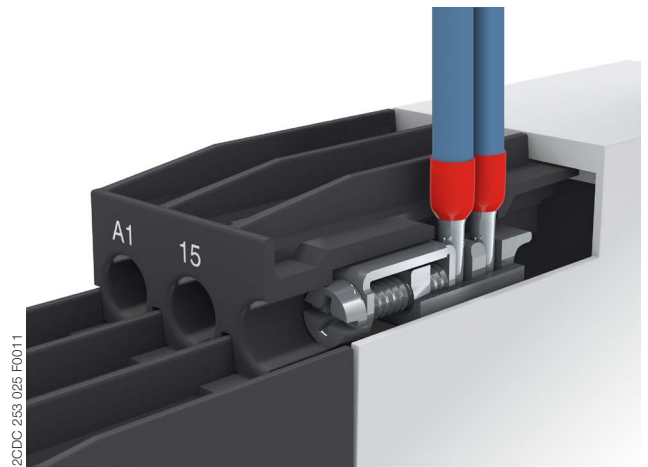

### Double-chamber cage connection terminals

- Terminal spaces for different wire sizes:  
fine-strand with/without wire end ferrule:  
1 x 0.5-2.5 mm<sup>2</sup> (2 x 20 - 14 AWG),  
2 x 0.5-1.5 mm<sup>2</sup> (2 x 20 - 16 AWG)  
rigid:  
1 x 0.5-4 mm<sup>2</sup> (1 x 20 - 12 AWG),  
2 x 0.5-2.5 mm<sup>2</sup> (2 x 20 - 14 AWG)
- One screw for opening and closing of both cages
- Pozidrive screws for pan- or crosshead screwdrivers according to DIN ISO 2380-1 Form A 0.8 x 4 mm (0.0315 x 0.157 in), DIN ISO 8764-1 PZ1 ø 4.5 mm (0.177 in)

Both the Easy Connect Technology with push-in terminals and screw connection technology with double-chamber cage connection terminals have the same connection geometry as well as terminal position.

## Functions

### Operating controls

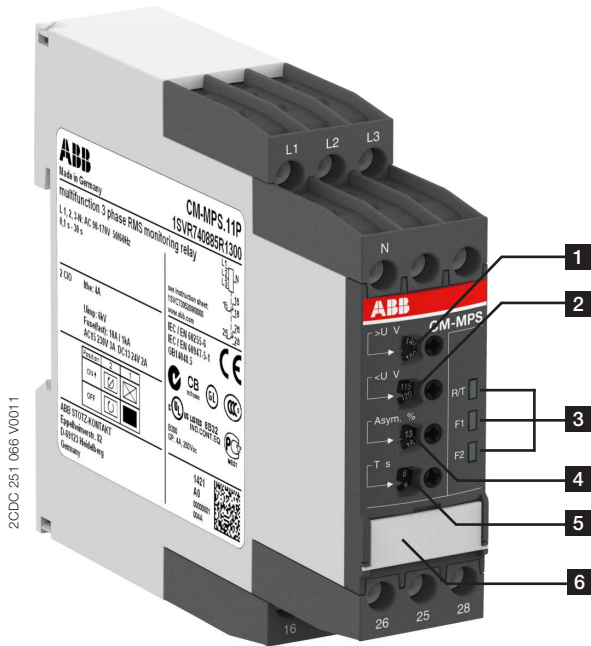

- 1** Adjustment of the hysteresis  $>U$  for overvoltage
- 2** Adjustment of the threshold value  $<U$  for undervoltage
- 3** Indication of operational states  
R/T: red LED – Relay status / timing  
F1: yellow LED – Fault message  
F2: yellow LED – Fault message
- 4** Adjustment of the threshold value Asym. for phase unbalance
- 5** Adjustment of the tripping delay  $T_v$
- 6** DIP switches (see DIP switch functions)

### Application

The three-phase monitoring relays CM-MPS.x1 are designed for use in three-phase mains for monitoring the phase parameters phase sequence, phase failure, over- and undervoltage as well as phase unbalance. The CM-MPS.11 and CM-MPS.21 also monitor the neutral for interruption and are suitable for monitoring single-phase mains.

The CM-MPS.x1 provide an adjustable tripping delay and work according to the closed-circuit principle.

### Operating mode

The CM-MPS.x1 have 2 c/o (SPDT) contacts and are available for 3-wire AC systems (CM-MPS.31, CM-MPS.41) and 4-wire AC systems (CM-MPS.11, CM-MPS.21).

The units are adjusted with front-face operating controls. The selection of ON-  or OFF-  delay and phase sequence monitoring activated  or phase sequence monitoring deactivated  is made with DIP switches. Potentiometers, with direct reading scale, allow the adjustment of the threshold values for overvoltage ( $>U$ ), undervoltage ( $<U$ ), phase unbalance (Asym %) and the tripping delay  $T_v$ . The tripping delay  $T_v$  is adjustable over a range of instantaneous to a 30 s delay. Timing is displayed by a flashing yellow LED labelled R/T.

For monitoring single-phase mains, all three external conductors (L1, L2, L3) have to be jumpered and connected as one single conductor. Phase sequence monitoring has to be deactivated and the threshold value for phase unbalance has to be set to the maximum (25 %).

## Adjustment potentiometer

### Threshold values

By means of three separate potentiometers with direct reading scales, the threshold values for over- and undervoltage as well as for phase unbalance can be adjusted within the measuring range.















	Measuring range for overvoltage	Measuring range for undervoltage	Measuring range for phase unbalance
<b>CM-MPS.11</b>	3 x 120-170 V AC	3 x 90-130 V AC	2-25 % of average of phase voltages
<b>CM-MPS.21</b>	3 x 240-280 V AC	3 x 180-220 V AC	
<b>CM-MPS.31</b>	3 x 220-300 V AC	3 x 160-230 V AC	
<b>CM-MPS.41</b>	3 x 420-500 V AC	3 x 300-380 V AC	

### Tripping delay $T_v$

The tripping delay  $T_v$  can be adjusted within a range of 0.1 to 30 s by means of a potentiometer with logarithmic scale. By turning to the left stop, the tripping delay can be switched off.

## Indication of operational states

### LEDs, status information and fault messages

Operational state	R/T: LED yellow	F1: LED red	F2: LED red
Control supply voltage applied, output relay energized		-	-
Tripping delay $T_v$ active		-	-
Phase failure	-		
Phase sequence	-	 alternating	
Overvoltage	-		-
Undervoltage	-	-	
Phase unbalance	-		
Interruption of the neutral	-		
Adjustment error <sup>1)</sup>			

<sup>1)</sup> Overlapping of the threshold values: The threshold value for overvoltage is set to a smaller value than the threshold value for undervoltage.

## Function descriptions / diagrams

### Interrupted neutral monitoring

The interruption of the neutral in the main to be monitored is detected by means of phase unbalance evaluation. If the star point is displaced by asymmetrical load in the three-phase main, an interrupted neutral will be detected. Determined by the system, in case of unloaded neutral, i.e. symmetrical load between all three phases, it may happen that an interruption of the neutral will not be detected.

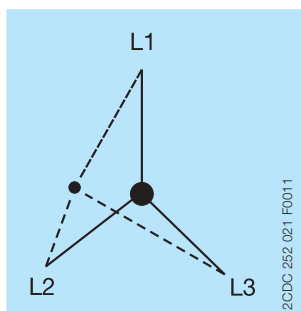

**Phase sequence and phase failure monitoring**

Applying control supply voltage begins the fixed start-up delay  $T_s$ . When  $T_s$  is complete and all phases are present with correct voltage, the output relays energize and the yellow LED R/T is on.

*Phase sequence monitoring:*

If phase sequence monitoring is activated (DIP switch 2 = OFF), the output relays de-energize as soon as a phase sequence error occurs. The fault is displayed by alternated flashing of the LEDs F1 and F2. The output relays re-energize automatically as soon as the phase sequence is correct again.

If phase sequence monitoring is deactivated (DIP switch 2 = ON), a phase sequence error will not cause tripping of the relays. The output relays do not change state and the LEDs F1 and F2 don't flash.

*Phase failure monitoring:*

The output relays de-energize instantaneously if a phase failure occurs. The fault is indicated by lightning of LED F1 and flashing of LED F2. The output relays re-energize automatically as soon as the voltage returns to the tolerance range.

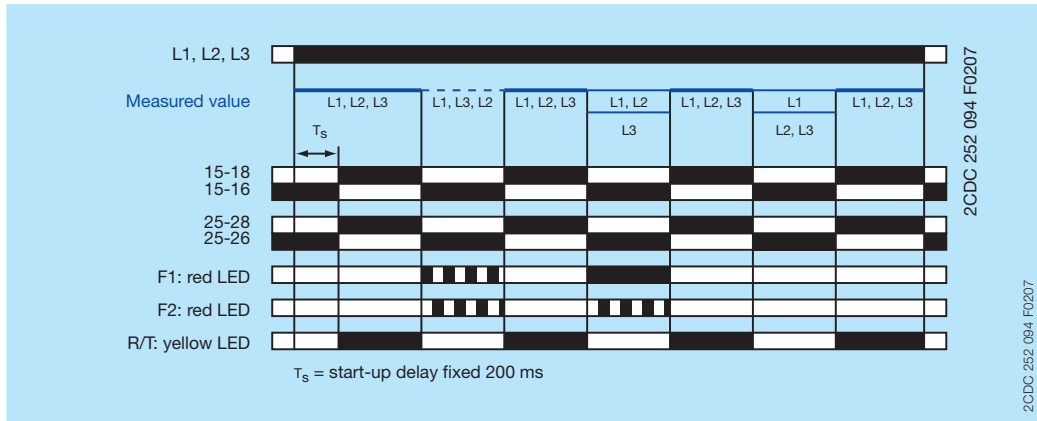

### Over- and undervoltage monitoring

Applying control supply voltage begins the fixed start-up delay  $T_s$ . When  $T_s$  is complete and all phases are present with correct voltage and with correct phase sequence, the output relays energize and the yellow LED R/T is on.

Type of tripping delay = ON-delay ☒

If the voltage to be monitored exceeds or falls below the set threshold value, the output relays de-energize after the set tripping delay  $T_v$  is complete. The LED R/T flashes during timing and turns off as soon as the output relays de-energize. The output relays re-energize automatically as soon as the voltage returns to the tolerance range, taking into account a fixed hysteresis of 5 %. The LED R/T is on.

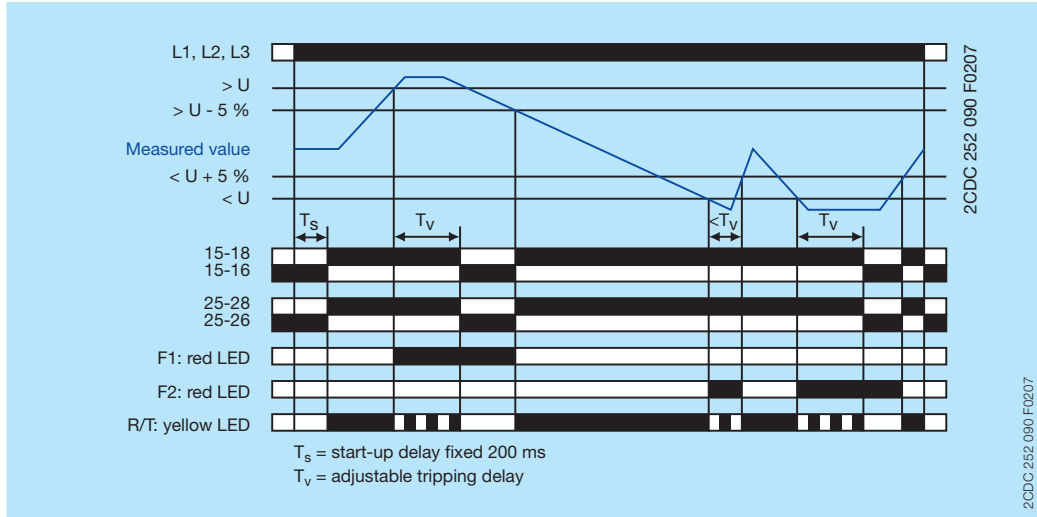

Type of tripping delay = OFF-delay ■

If the voltage to be monitored exceeds or falls below the set threshold value, the output relays de-energize instantaneously and the LED R/T turns off.

As soon as the voltage returns to the tolerance range, taking into account a fixed hysteresis of 5 %, the output relays re-energize automatically after the set tripping delay  $T_v$  is complete. The LED R/T flashes during timing and turns steady when timing is complete.

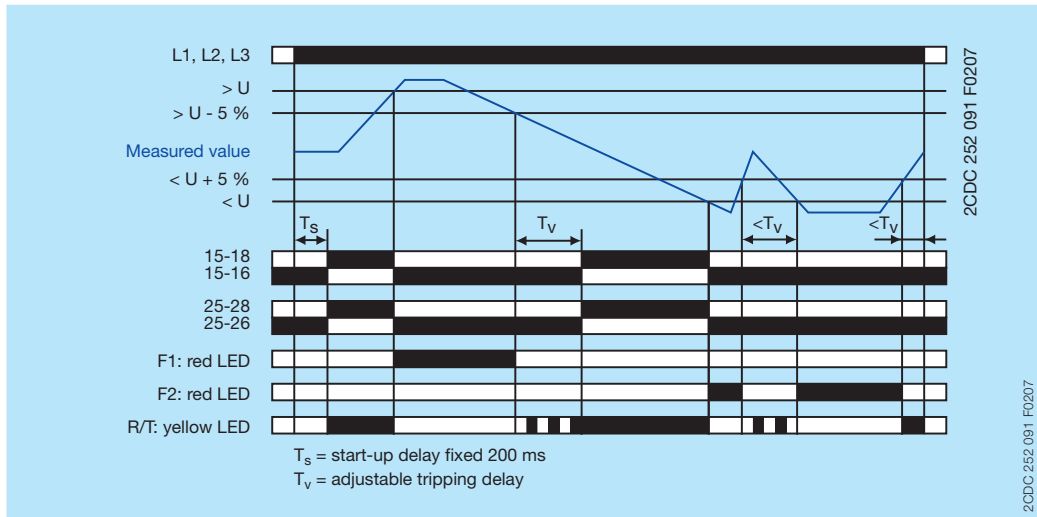

### Phase unbalance monitoring

Applying control supply voltage begins the fixed start-up delay  $T_s$ . When  $T_s$  is complete and all phases are present with correct voltage and with correct phase sequence, the output relays energize and the yellow LED R/T is on.

Type of tripping delay = ON-delay ☒

If the voltage to be monitored exceeds or falls below the set phase unbalance threshold value, the output relays de-energize after the set tripping delay  $T_v$  is complete. The LED R/T flashes during timing and turns off as soon as the output relays de-energize.

The output relays re-energize automatically as soon as the voltage returns to the tolerance range, taking into account a fixed hysteresis of 20 %. The LED R/T is on.

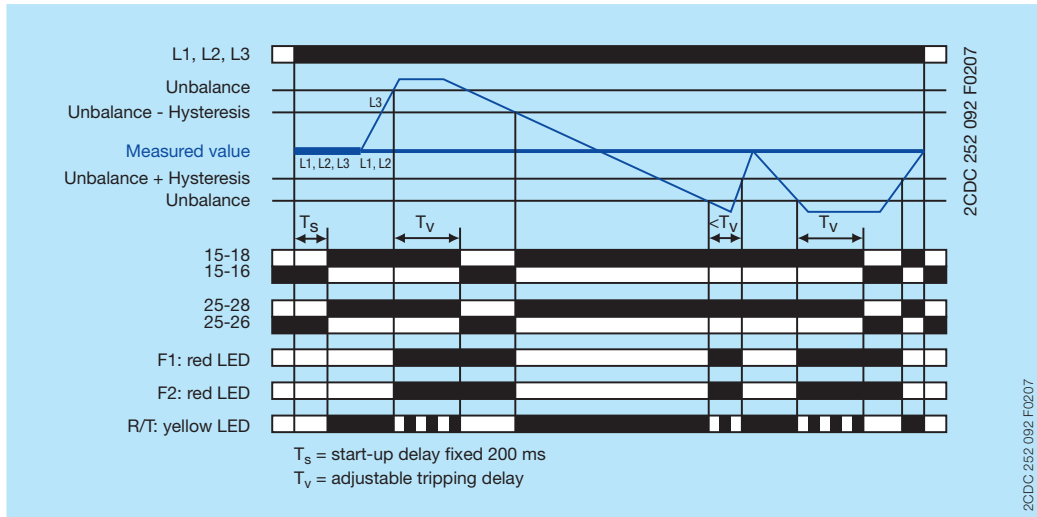

Type of tripping delay = OFF-delay ■

If the voltage to be monitored exceeds or falls below the set phase unbalance threshold value, the output relays de-energize instantaneously and the LED R/T turns off.

As soon as the voltage returns to the tolerance range, taking into account a fixed hysteresis of 20 %, the output relays re-energize automatically after the set tripping delay  $T_v$  is complete. The LED R/T flashes during timing and turns steady when timing is complete.

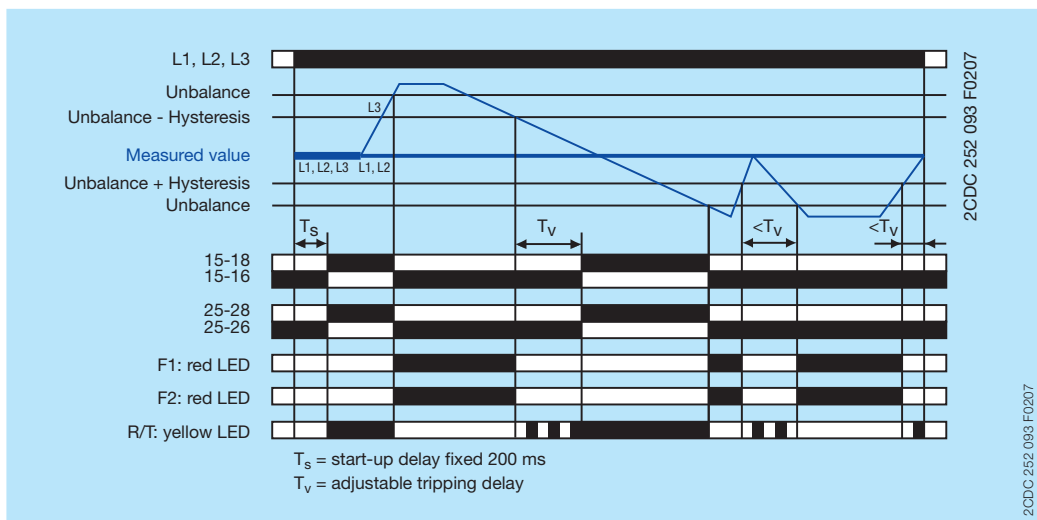



## Electrical connection

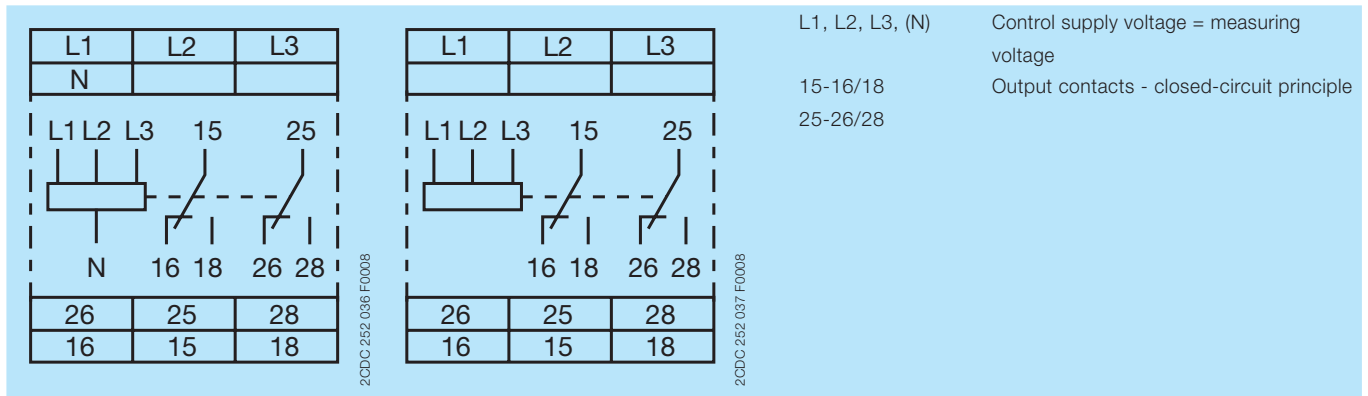

Connection diagram  
CM-MPS.11 and CM-MPS.21

Connection diagram  
CM-MPS.31 and CM-MPS.41

## DIP switches

Position	2	1
ON ↑		
OFF		

26DC 252 040 F0008

<p><b>1 Timing function</b></p>	<p>ON    ON-delayed</p> <p>OFF    OFF-delayed</p>	<p>In case of a fault, the de-energizing of the output relays and the respective fault message are suppressed for the adjusted tripping delay <math>T_v</math>.</p> <p>In case of a fault, the output relays de-energize instantaneously and a fault message is displayed and stored for the duration of the adjusted tripping delay <math>T_v</math>. Thereby, also momentary undervoltage conditions are recognized.</p>
<p><b>2 Phase sequence monitoring</b></p>	<p>ON    deactivated</p> <p>OFF    activated</p>	<p>Phase sequence errors will not cause tripping of the relays.</p> <p>The output relays de-energize as soon as a phase sequence error occurs. The output relays re-energize automatically as soon as the phase sequence is correct again.</p>

## Technical data

Data at  $T_a = 25\text{ °C}$  and rated values, unless otherwise indicated

### Input circuit

Type	CM-MPS.11	CM-MPS.21	CM-MPS.31	CM-MPS.41
<b>Supply circuit = measuring circuit</b>	<b>L1, L2, L3, N</b>		<b>L1, L2, L3</b>	
Rated control supply voltage $U_s$ = measuring voltage	3 x 90-170 V AC	3 x 180-280 V AC	3 x 160-300 V AC	3 x 300-500 V AC
Rated control supply voltage $U_s$ tolerance	-15...+10 %			
Rated frequency	50/60 Hz			
Frequency range	45-65 Hz			
Typical current / power consumption	25 mA / 10 VA (115 V AC)	25 mA / 18 VA (230 V AC)	25 mA / 10 VA (230 V AC)	25 mA / 18 VA (400 V AC)

<b>Measuring circuit</b>		<b>L1, L2, L3, N</b>		<b>L1, L2, L3</b>	
Monitoring functions	Phase failure	■	■	■	■
	Phase sequence	can be switched off	can be switched off	can be switched off	can be switched off
	Automatic phase sequence correction	-	-	-	-
	Over-/undervoltage	■	■	■	■
	Phase unbalance	■	■	■	■
	Interrupted neutral	■	■	-	-
Measuring range	Overvoltage	3 x 120-170 V AC	3 x 240-280 V AC	3 x 220-300 V AC	3 x 420-500 V AC
	Undervoltage	3 x 90-130 V AC	3 x 180-220 V AC	3 x 160-230 V AC	3 x 300-380 V AC
	Phase unbalance	2-25 % of average of phase voltages			
Thresholds	Overvoltage	adjustable within measuring range			
	Undervoltage	adjustable within measuring range			
	Phase unbalance (switch-off value)	adjustable within measuring range			
Hysteresis related to the threshold value	Over-/undervoltage	fixed 5 %			
	Phase unbalance	fixed 20 %			
Rated frequency of the measuring signal		50/60 Hz			
Frequency range of the measuring signal		45-65 Hz			
Maximum measuring cycle time		100 ms			
Accuracy within the rated control supply voltage tolerance		$\Delta U \leq 0.5\%$			
Accuracy within the temperature range		$\Delta U \leq 0.06\% / \text{°C}$			
Measuring method		True RMS			

<b>Timing circuit</b>	
Start-up delay $T_s$	fixed 200 ms
Tripping delay $T_v$	ON- or OFF-delay 0 s; 0.1-30 s adjustable
Repeat accuracy (constant parameters)	$< \pm 0.2\%$
Accuracy within the rated control supply voltage tolerance	$\Delta t \leq 0.5\%$
Accuracy within the temperature range	$\Delta t \leq 0.06\% / \text{°C}$

### User interface

<b>Indication of operational states</b>	
Relay status / timing	R/T yellow LED
Fault message	F1 red LED
Fault message	F2 red LED

Details see table 'LEDs, status information and fault messages' on page 5 and 'Function descriptions / diagrams' on page 5.

## Output circuits

Kind of output	15-16/18	relay, 1st c/o (SPDT) contact
	25-26/28	relay, 2nd c/o (SPDT) contact
		1 x 2 (SPDT) contacts
Operating principle	closed-circuit principle <sup>1)</sup>	
Contact material	AgNi alloy, Cd free	
Rated operational voltage U <sub>o</sub> (IEC/EN 60947-1)	250 V	
Minimum switching voltage / Minimum switching current	24 V / 10 mA	
Maximum switching voltage / Maximum switching current	see load limit curves	
Rated operational current I <sub>e</sub> (IEC/EN 60947-5-1)	AC12 (resistive) at 230 V	4 A
	AC15 (inductive) at 230 V	3 A
	DC12 (resistive) at 24 V	4 A
	DC13 (inductive) at 24 V	2 A
AC rating (UL 508)	Utilization category (Control Circuit Rating Code)	B 300
	max. rated operational voltage	300 V AC
	max. continuous thermal current at B 300	5 A
	max. making/breaking apparent power at B 300	3600/360 VA
Mechanical lifetime	30 x 10 <sup>6</sup> switching cycles	
Electrical lifetime	AC12, 230 V, 4 A	0.1 x 10 <sup>6</sup> switching cycles
Maximum fuse rating to achieve short-circuit protection	n/c contact	6 A fast-acting
	n/o contact	10 A fast-acting

## General data

MTBF	on request															
Duty time	100 %															
Dimensions (W x H x D)	product dimensions	22.5 x 85.6 x 103.7 mm (0.89 x 3.37 x 4.08 in)														
	packaging dimensions	97 x 109 x 30 mm (3.82 x 4.29 x 1.18 in)														
Weight	net weight	<b>Screw connection technology</b>		<b>Easy Connect Technology (push-in)</b>												
		CM-MPS.11	0.148 kg (0.326 lb)	0.137 kg (0.302 lb)												
		CM-MPS.21	0.146 kg (0.322 lb)	0.135 kg (0.298 lb)												
		CM-MPS.31	0.142 kg (0.313 lb)	0.133 kg (0.293 lb)												
	gross weight	CM-MPS.41	0.140 kg (0.309 lb)	0.132 kg (0.291 lb)												
		CM-MPS.11	0.173 kg (0.381 lb)	0.162 kg (0.357 lb)												
		CM-MPS.21	0.171 kg (0.377 lb)	0.160 kg (0.353 lb)												
		CM-MPS.31	0.167 kg (0.368 lb)	0.158 kg (0.348 lb)												
	CM-MPS.41	0.165 kg (0.364 lb)	0.157 kg (0.346 lb)													
Mounting	DIN rail (IEC/EN 60715), snap-on mounting without any tool															
Mounting position	any															
Minimum distance to other units	<table border="1"> <thead> <tr> <th>CM-MPS.11</th> <th>CM-MPS.21</th> <th>CM-MPS.31</th> <th>CM-MPS.41</th> </tr> </thead> <tbody> <tr> <td colspan="4">10 mm (0.39 in) in case of continuous voltage of ...</td> </tr> <tr> <td>&gt; 120 V</td> <td>&gt; 240 V</td> <td>&gt; 220 V</td> <td>&gt; 400 V</td> </tr> </tbody> </table>				CM-MPS.11	CM-MPS.21	CM-MPS.31	CM-MPS.41	10 mm (0.39 in) in case of continuous voltage of ...				> 120 V	> 240 V	> 220 V	> 400 V
	CM-MPS.11	CM-MPS.21	CM-MPS.31	CM-MPS.41												
10 mm (0.39 in) in case of continuous voltage of ...																
> 120 V	> 240 V	> 220 V	> 400 V													
Material of housing	UL 94 V-0															
Degree of protection	housing	IP50														
	terminals	IP20														

<sup>1)</sup> Closed-circuit principle: Output relay(s) de-energize(s) if measured value exceeds or falls below the adjusted threshold value.

## Electrical connection

		Screw connection technology	Easy Connect Technology (push-in)
Wire size	fine-strand with(out) wire end ferrule	1 x 0.5-2.5 mm <sup>2</sup> (1 x 20-14 AWG) 2 x 0.5-1.5 mm <sup>2</sup> (2 x 20-16 AWG)	2 x 0.5-1.5 mm <sup>2</sup> (2 x 20-16 AWG)
	rigid	1 x 0.5-4 mm <sup>2</sup> (1 x 20-12 AWG) 2 x 0.5-2.5 mm <sup>2</sup> (2 x 20-14 AWG)	2 x 0.5-1.5 mm <sup>2</sup> (2 x 20-16 AWG)
Stripping length		8 mm (0.32 in)	
Tightening torque		0.6 - 0.8 Nm (5.31 - 7.08 lb.in)	-

## Environmental data

Ambient temperature ranges	operation	-25...+60 °C
	storage	-40...+85 °C
Damp heat, cyclic (IEC/EN 60068-2-30)		55 °C, 6 cycles
Climatic category		3K3
Vibration, sinusoidal (IEC/EN 60255-21-1)		Class 2
Shock (IEC/EN 60255-21-2)		Class 2

## Isolation data

Type	CM-MPS.11	CM-MPS.21	CM-MPS.31	CM-MPS.41
Rated insulation voltage U <sub>i</sub>	input circuit / output circuit	600 V		
	output circuit 1 / output circuit 2	300 V		
Rated impulse withstand voltage U <sub>imp</sub> (IEC/EN 60664)	input circuit	6 kV, 1.2/50 μs		
	output circuit	4 kV, 1.2/50 μs		
Test voltage between all isolated circuits (routine test)		2.5 kV, 50 Hz, 1 s		
Basic insulation		600 V		
Protective separation (IEC/EN 61140, EN 50178)	input circuit / output circuit	yes	-	
Pollution degree (IEC/EN 60664, IEC/EN 60255-5)		3		
Overvoltage category (IEC/EN 60664, IEC/EN 60255-5)		III		

## Standards

Product standard	IEC/EN 60255-6, EN 50178
Low Voltage Directive	2006/95/EC
EMC directive	2004/108/EC
RoHS directive	2002/95/EC

Electromagnetic compatibility

Type		CM-MPS.11	CM-MPS.21	CM-MPS.31	CM-MPS.41
Interference immunity to		IEC/EN 61000-6-1, IEC/EN 61000-6-2			
electrostatic discharge	IEC/EN 61000-4-2	Level 3 (6 kV / 8 kV)			
radiated, radio-frequency, electromagnetic field	IEC/EN 61000-4-3	Level 3 (10 V/m)			
electrical fast transient / burst	IEC/EN 61000-4-4	Level 3 (2 kV / 2 kHz)			
surge	IEC/EN 61000-4-5	Level 4 (2 kV L-N)		Level 4 (2 kV L-L)	
conducted disturbances, induced by radio-frequency fields	IEC/EN 61000-4-6	Level 3 (10 V)			
harmonics and interharmonics	IEC/EN 61000-4-13	Class 3			
Interference emission		IEC/EN 61000-6-3, IEC/EN 61000-6-4			
high-frequency radiated	IEC/CISPR 22, EN 55022	Class B			
high-frequency conducted	IEC/CISPR 22, EN 55022	Class B			

Technical diagrams

Load limit curves

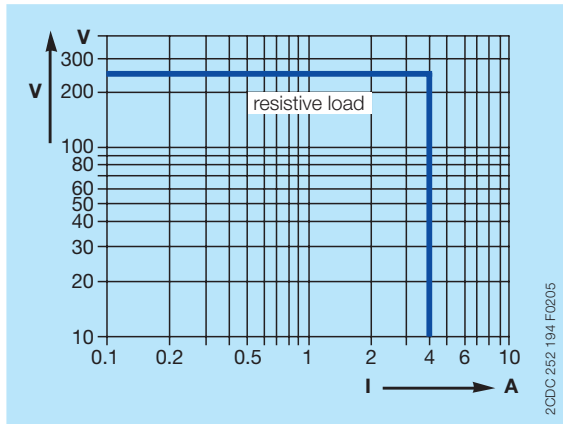

AC load (resistive)

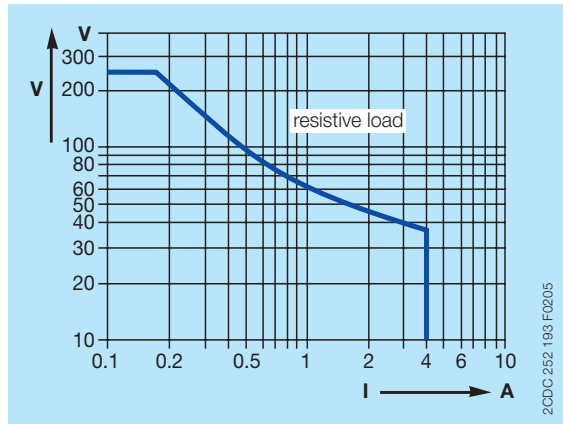

DC load (resistive)

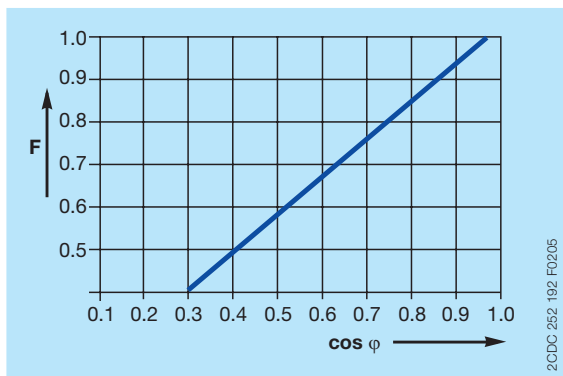

Derating factor F for inductive AC load

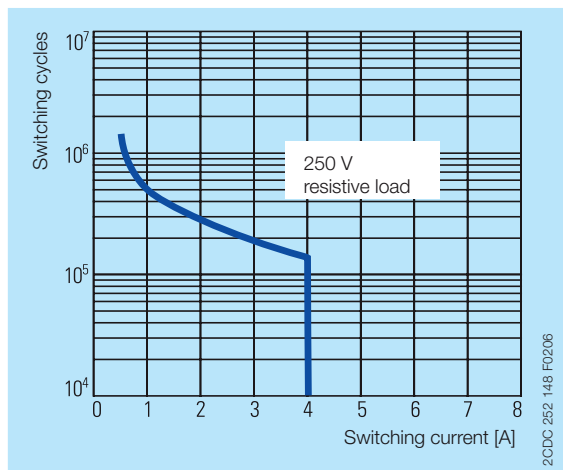

Contact lifetime

## Dimensions

in **mm** and *inches*

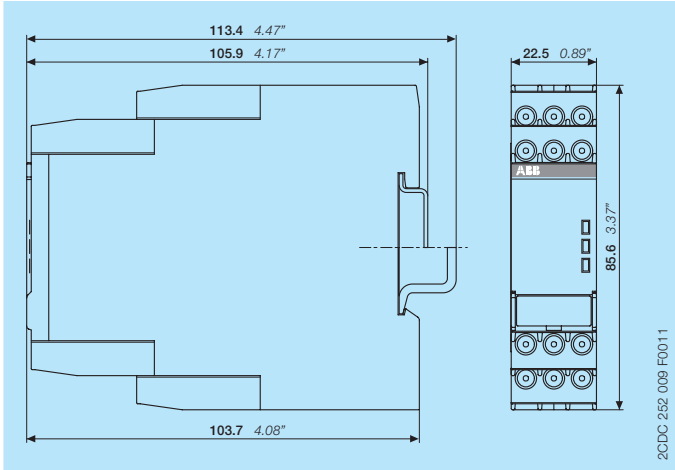

## Accessories

in **mm** and *inches*

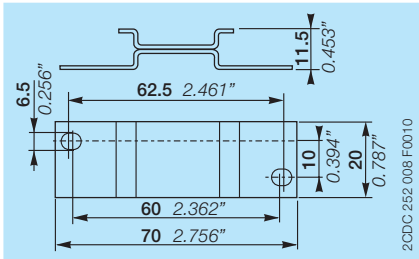

ADP.01 - Adapter for screw mounting

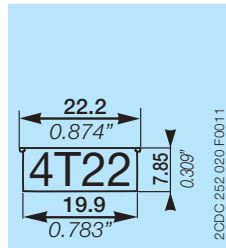

MAR.12 - Marker label for devices with DIP switches

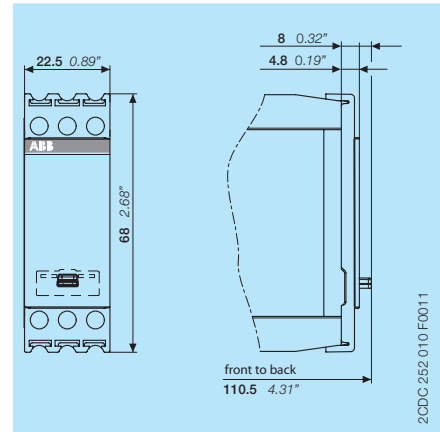

COV.11 - Sealable transparent cover

## Further documentation

Document title	Document type	Document number
Electronic products and relays	Technical catalogue	2CDC 110 004 C02xx
CM-MPS.11, CM-MPS.21, CM-MPS.31, CM-MPS.41	Instruction manual	1SVC 730 520 M0000

You can find the documentation on the internet at [www.abb.com/lowvoltage](http://www.abb.com/lowvoltage) -> Control Products -> Electronic Relays and Controls -> Three Phase Monitors.

# Contact us

## **ABB STOTZ-KONTAKT GmbH**

P. O. Box 10 16 80  
69006 Heidelberg, Germany  
Phone: +49 (0) 6221 7 01-0  
Fax: +49 (0) 6221 7 01-13 25  
E-mail: info.desto@de.abb.com

You can find the address of your  
local sales organisation on the  
ABB home page  
<http://www.abb.com/contacts>  
-> Low Voltage Products and Systems

### **Note:**

We reserve the right to make technical changes or modify the contents of this document without prior notice. With regard to purchase orders, the agreed particulars shall prevail. ABB AG does not accept any responsibility whatsoever for potential errors or possible lack of information in this document.

We reserve all rights in this document and in the subject matter and illustrations contained therein. Any reproduction, disclosure to third parties or utilization of its contents – in whole or in parts – is forbidden without prior written consent of ABB AG.

Copyright© 2012 ABB  
All rights reserved